

D28 Connector

90° Connector (Inner)

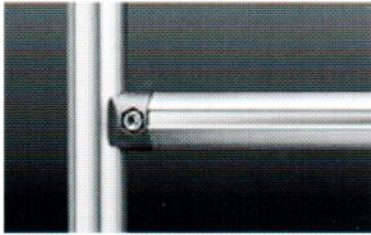

■ Material/Technical data

Material: Aluminum die-cast
 Environment: RoHS compliant
 Weight: 54g

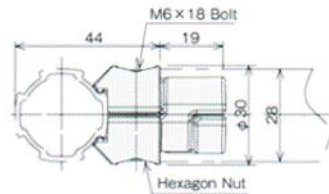
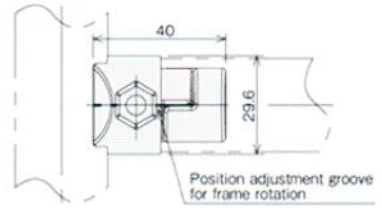

Part No.
PTC-APJ-1

L- Connector Outer Type

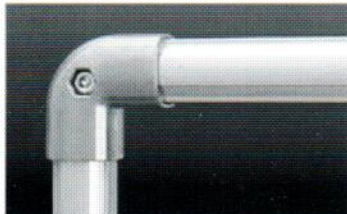

■ Material/Technical data

Material: Aluminum die-cast
 Environment: RoHS compliant
 Weight: 96g

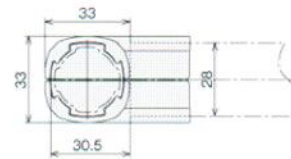
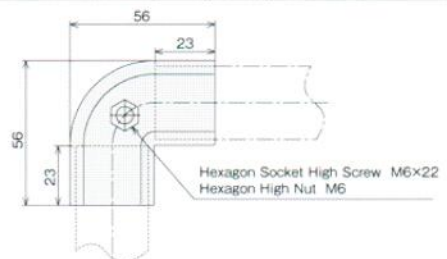

Part No.
PTC-APJ-2

45-Degree Connector Outer Type

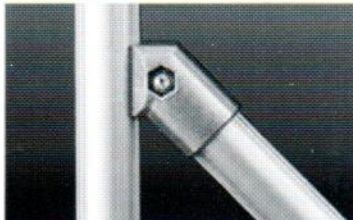

■ Material/Technical data

Material: Aluminum die-cast
 Environment: RoHS compliant
 Weight: 61 g

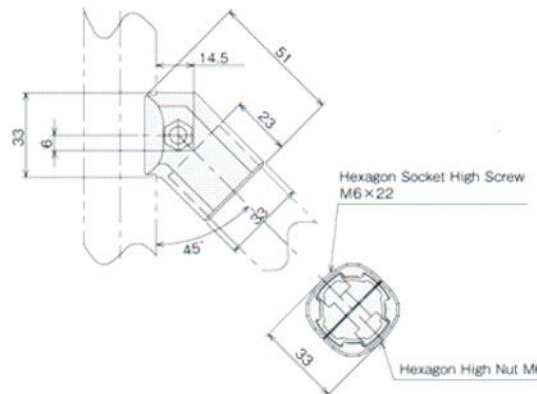

Part No.
PTC-APJ-3

Installation with outer connectors and compatible frames

